

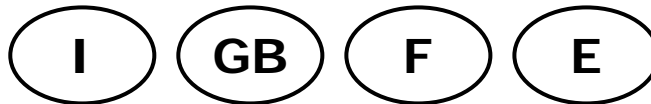

**Manual
for
the
maintenance
and
repair
of
Bertolini
piston
pumps**

**SERIES:
W-WJ-TW-KWE**



ATTENTION: the following instructions are exclusively intended to skilled operators.

MANUFACTURER INFORMATION:

Manufacturer: IDROMECCANICA BERTOLINI S.p.A.
Address: Via F.lli Cervi 35/1
42100 REGGIO EMILIA - ITALIA
Tel. +39 0522 306641 Fax +39 0522 306648
E-mail: email@bertolinipumps.com
Internet: www.bertolinipumps.com

Issued: June 2004
Edition: 00/ June 2004

PRELIMINARY REMARKS:

This manual has been prepared and illustrated to assist you in the repair/ maintenance of your piston pump and it is exclusively intended to skilled operators making use of the proper tool kit.



Idromeccanica Bertolini S.p.A. declines any liability for damage or accidents to persons or property which may arise from repairs attempts by unskilled people in the mechanical field.

ENGLISH

| | |
|---|---------|
| 1-PUMPS MODELS AND COMPONENTS IDENTIFICATION..... | pag. 4 |
| 2-CHECK VALVES SERVICE..... | pag.5 |
| 3-PACKING/ SEAL SERVICE..... | pag.6 |
| 3.1-PACKING/ SEAL KITS AND EXTRACTORS..... | pag.7 |
| 3.2-HEAD REASSEMBLY..... | pag.8 |
| 4-CERAMIC PLUNGERS SERVICE..... | pag.9 |
| 5-PLUNGER OIL SEALS SERVICE..... | pag.10 |
| 6-SHAFT OIL SEALS SERVICE..... | pag.11 |
| 7-REPAIRS TOOLS CHART..... | pag. 12 |

1- PUMPS MODELS AND COMPONENTS IDENTIFICATION

Models:

W SERIES PUMPS:

-WEL
-WE
-WESL
-WES
-WAL
-WA
-WASL
-WAS
-WSG

WJ SERIES PUMPS:

-WJL
-WJL-F
-WJC
-WJS
-WJS-F
-WJH
-WJH-F
-WJG

TW SERIES PUMPS:

-TW
-TWS
-TWSG

KWE SERIES PUMPS:

-KWE

Components identification:

In case of doubts, it is useful to identify the pumps components by referring to the picture and charts hereafter:

1. Identification label
2. Oil sight glass with dipstick
3. Pump shaft
4. Outlet
5. Inlet
6. Inlet valve cap
7. Pump head
8. Outlet valve cap

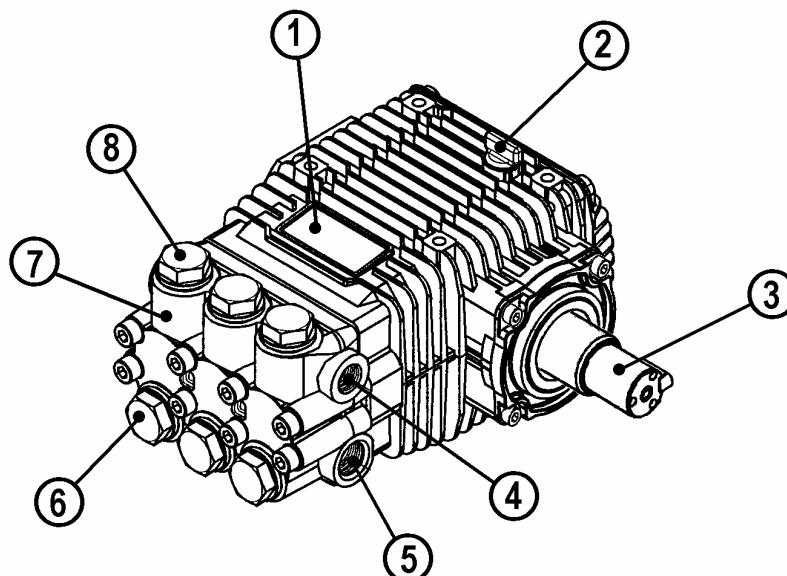

2-CHECK VALVES SERVICE



STEP 1:
Unscrew the caps with an appropriate Allen wrench
(see chart 1)
Caution: using a 12- point wrench it is possible
to damage the hexagon of the valve cap.
(Fig. 1)

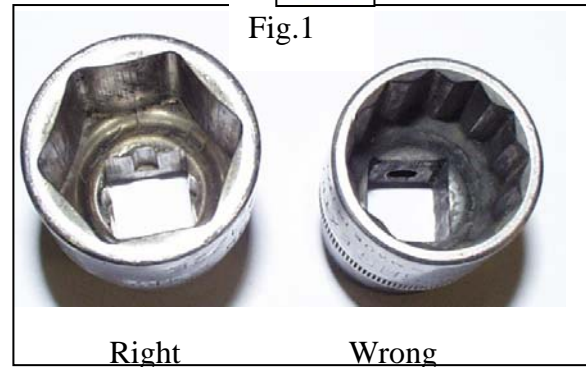

STEP 2:
Remove the check valves with a
pliers
(Fig.2)

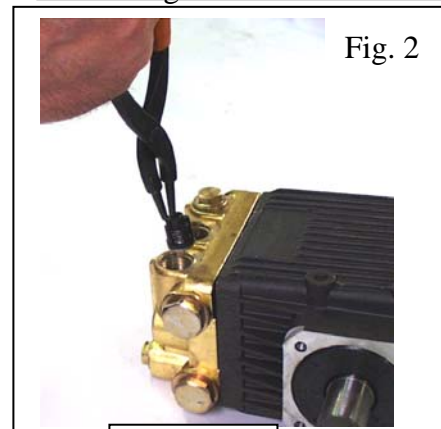

STEP 3:
Remove the OR with a little
screwdriver and replace it with a new one
(Fig. 3)

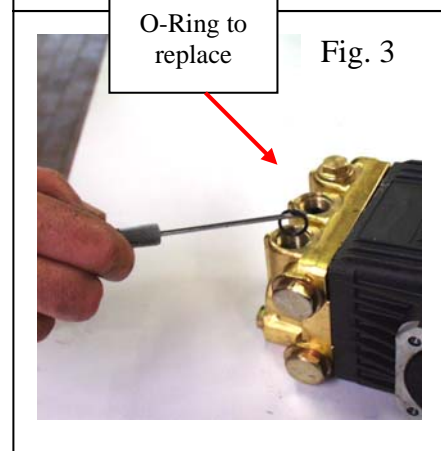

STEP 4:
Fit the new valve, make certain that it is correctly
located in its housing
(Fig. 4)

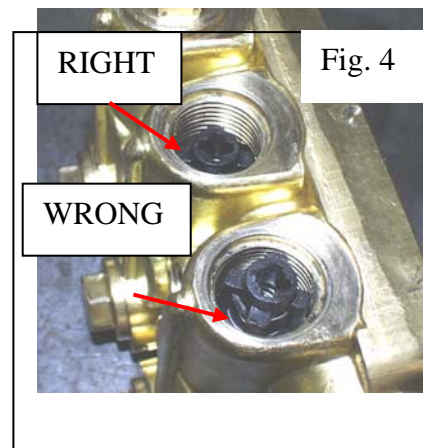

STEP 5:
Replace the O-Ring on the valve caps.
Tighten again the caps with a dynamometric wrench,
taking care to respect the torque wrench setting (see chart 1).
Apply one drop of Loctite 243 (blue)
on the cap thread

Chart 1 (Fig. 5-6)

| Torque settings for check valves caps | | |
|---------------------------------------|--------------|----------------|
| SERIES | WRENCH SIZES | TORQUE SETTING |
| WEL-WESL-WE-WES-WSG | mm 22 | 70 Nm 52 lbf |
| WJL-WJC-WJS-WJH-WJG | mm 14 | 50 Nm 37 lbf |
| TW-TWS-TWSG-KWE | mm 24 | 120 Nm 89 lbf |

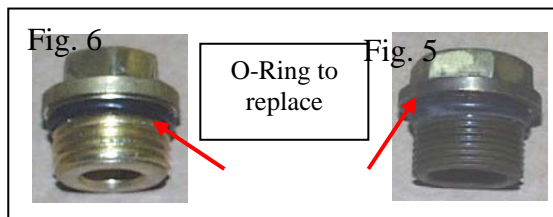

3-PACKING/ SEAL SERVICE



STEP 1:
Remove the head bolts using a proper Allen wrench (see chart 2) and remove the head with a plastic hammer

(Fig.7)

Chart 2

| Sizes of the wrench and torque wrench setting for the head bolts | | |
|--|-----------|----------------|
| Pumps | Wrench mm | Torque setting |
| W | 6 | 22Nm 16Lb ft |
| WJ | 6 | 22Nm 16Lb ft |
| TW-KWE | 5 | 15Nm 11Lb ft |

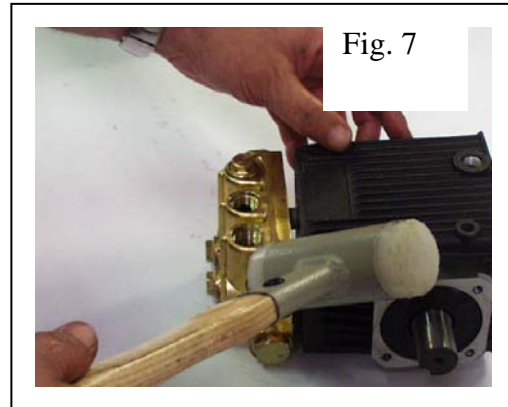

Fig. 7

STEP 2:
Remove the rear glands and the high pressure seals with the proper extractor.
(See the following page)

(Fig.8)

If you do not have an extractor you can use a screwdriver as a lever as indicated in the figure, and care not to score the seals seat

(Fig.9)

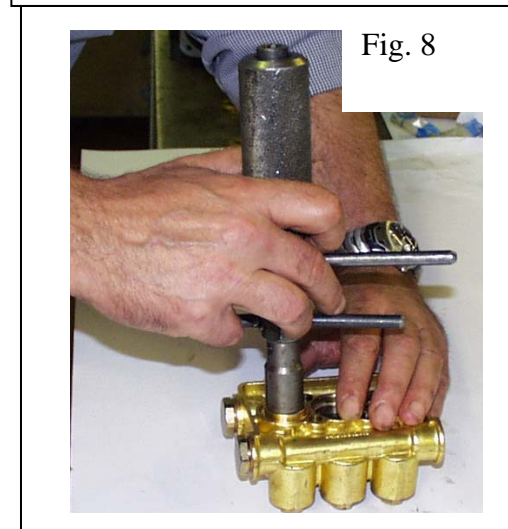

Fig. 8

STEP 3:
Replace the rear packings and the O-Ring of the rear gland.

After lubricating the head seats with grease locate in order:

- The new high pressure packings
- The front glands
- The rear glands with packing and O-Ring

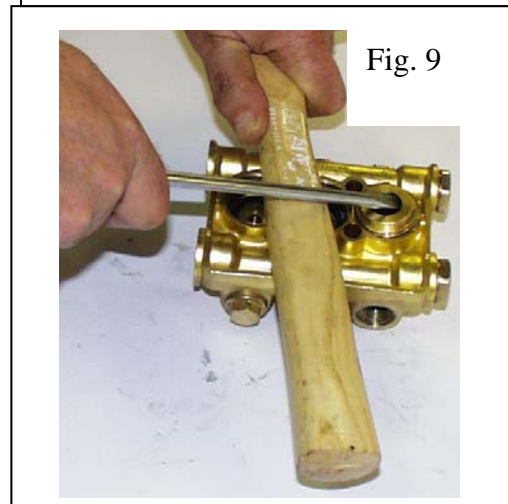
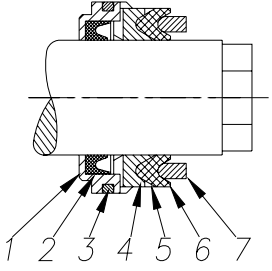

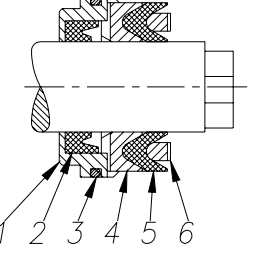

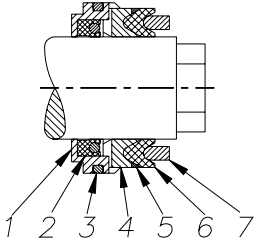

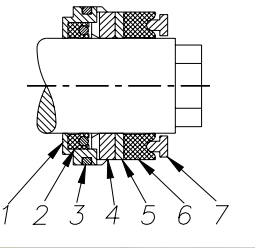



Fig. 9

The composition of the packings/ seals kits and the type of extractor to be used are indicated in the following page



3.1- PACKING/ SEAL KITS AND EXTRACTORS

| | | | |
|--|---|---|--|
| <p>Plungers Dia. 18mm</p> <p>WJL WJC WJS WJH</p> <p>WEL WESL WAL WASL</p> | <p>KIT N°10 (04.9812.97.3) (Extractor Part nr. 31.8763.97.3)</p> <ol style="list-style-type: none"> 1) rear gland (05.0222.53.2) 2) rear packing (80.2044.00.2) 3) O-Ring (80.3073.00.2) 4) front gland (05.0223.53.2) 5) restop ring (05.0221.32.2) 6) front seal (80.2061.00.2) 7) seal packer (05.0019.32.2)   | <p>Plungers Dia. 15mm</p> <p>WJL-F WJC-F WJS WJS-F WJH-F WJG</p> <p>WEL WE WES WAL WA WAS WSG</p> | <p>KIT N°61 (04.9819.97.3) (Extractor Part nr. 31.8762.97.3)</p> <ol style="list-style-type: none"> 1) rear gland (04.0104.53.2) 2) rear packing (80.2034.00.2) 3) O-Ring (80.3073.00.2) 4) front gland (04.0105.53.2) 5) front seal (80.2062.00.2) 6) seal packer (04.0019.32.2)   |
| <p>Plungers Dia. 18mm</p> <p>TW TWS KWE</p> | <p>KIT N°17 (05.9847.97.3) (Extractor Part nr. 31.8763.97.3)</p> <ol style="list-style-type: none"> 1) rear gland (05.0222.53.2) 2) rear packing (80.2043.00.2) 3) O-Ring (80.3073.00.2) 4) front gland (05.0223.53.2) 5) restop ring (05.0221.32.2) 6) front packing (80.2061.00.2) 7) seal packer (05.0019.32.2)   | <p>Plungers Dia. 18mm</p> <p>TWSG</p> | <p>KIT N°20 (05.9834.97.3) (Extractor Part nr. 31.8763.97.3)</p> <ol style="list-style-type: none"> 1) rear gland (05.0222.53.2) 2) rear packing (80.2043.00.2) 3) O-Ring (80.3073.00.2) 4) front gland (05.0226.53.2) 5) restop ring (80.2061.70.2) 6) front packing (80.2061.60.2) 7) seal packer (80.2061.60.2)   |

3.2-HEAD REASSEMBLY



STEP 1:

Rotate the pump shaft until the central piston is on the top dead center (T.D.C.).

(Fig. 10)

STEP 2:

Lubricate with grease the ceramic part of the plungers and install the head at right angles to the pistons axis until it completely rests on the crankcase.

(Fig.)11

STEP 3:

Tighten the bolts with a dynamometric wrench taking care to respect the torque wrench setting as indicated in chart 2.

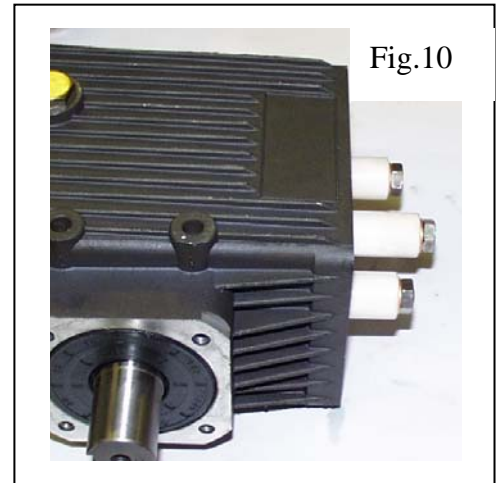

Fig.10

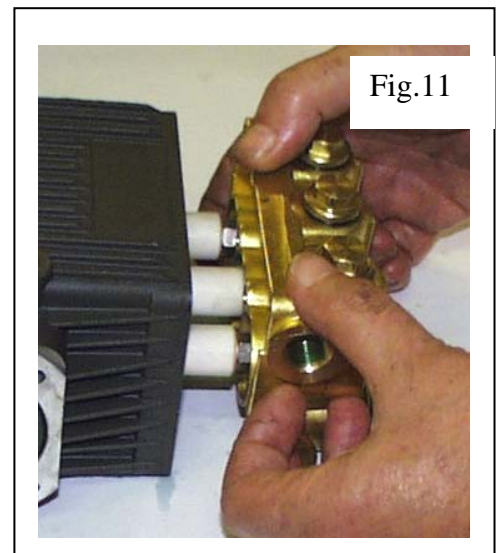

Fig.11

4-CERAMIC PLUNGERS SERVICE



STEP 1:
After removing the head as indicated at point 3
loose the nut with a wrench of 12 mm
(Fig. 12)

STEP 2:
Take out the ceramic plunger and the
O-Ring from the guide stem
(Fig. 13)

STEP 3:
Take out the splash guard washer and clean the guide stem with a
rag soaked with solvent; if necessary, polish with emery cloth 600
grain or superior.
(Fig. 14)

STEP 4:
-Install a new splash guard washer and a new
O-Ring on the guide stem after lubricating with oil
or grease.
-Install in the stem the new ceramic plunger and a
new washer.
-Apply one drop of Loctite 2701 on the stem thread
and tighten the nut with a dynamometric wrench
to (9.6Lbft) 13 Nm torque
(Fig. 15)

STEP 5:
Reassembly the head as indicated at point 3.2

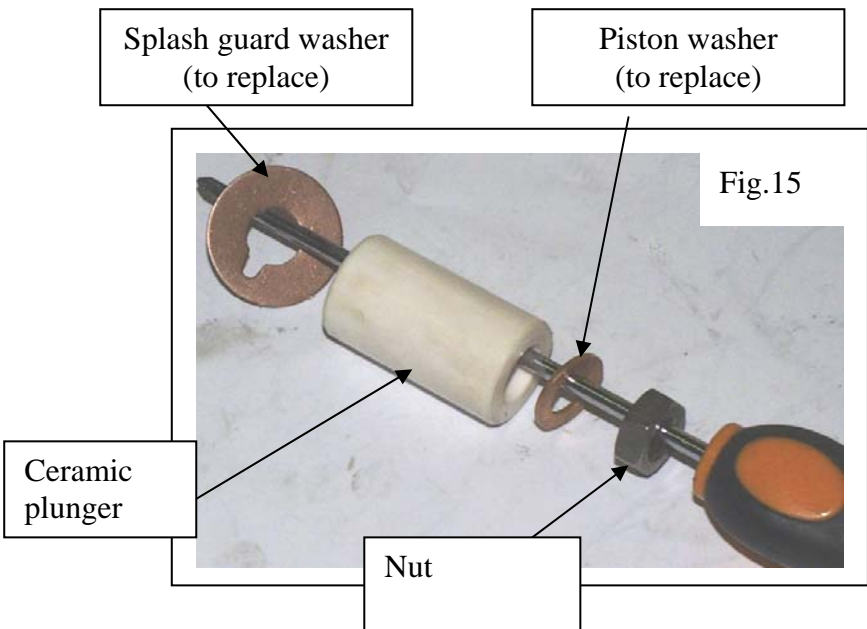
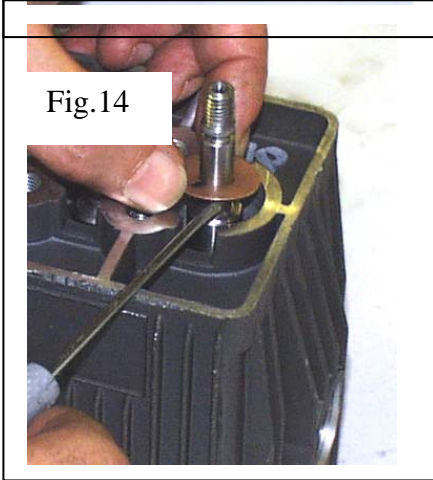
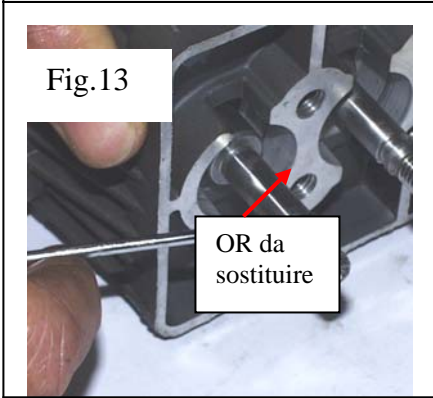
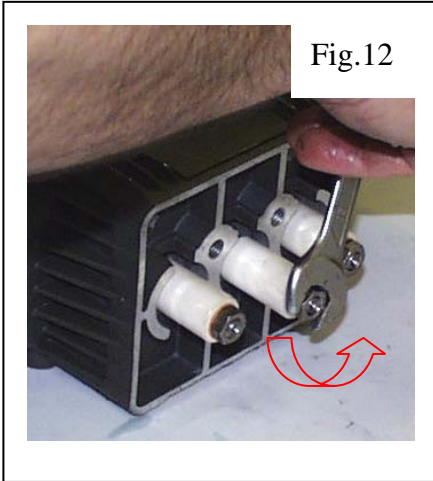



5-PLUNGER OIL SEALS SERVICE

Use a screwdriver 0.5x 3 with a sharp and shaped end as indicated at fig. 16



STEP 1:
Remove the ceramic plungers and the splash guard washers as previously described.

Position the tool in parallel to the piston axis with the end as indicated in the figure, and with a hammer, punch the metal structure of the oil seal.

(Fig. 17)

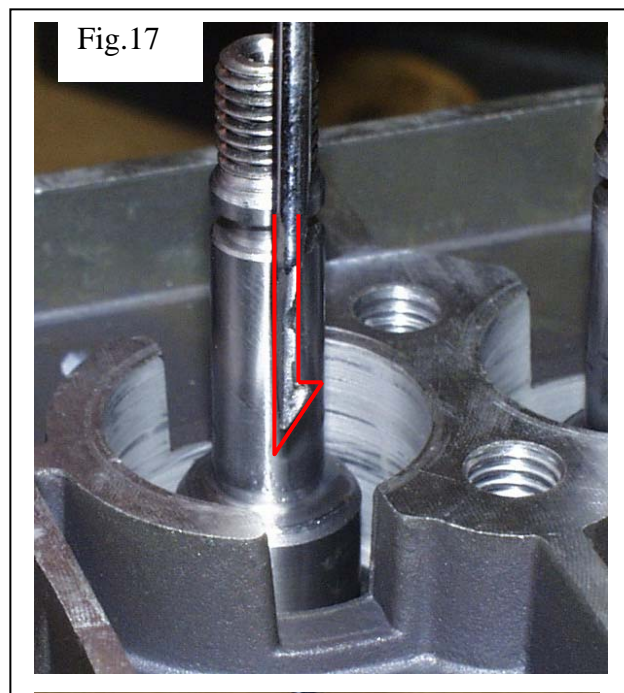

STEP 2:
Rotate the tool by 90° to allow the pawl is secured on the oil seal and push up.

(Fig. 18)

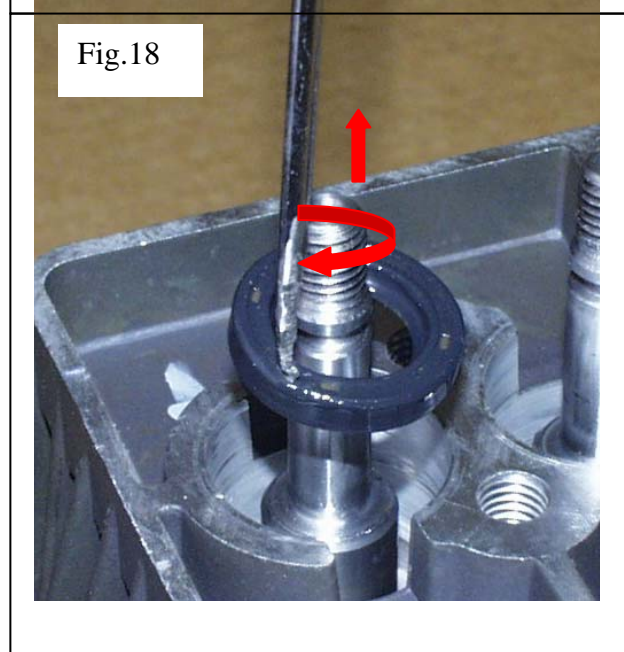

STEP 4:
Fit the new oil seal after lubricating with oil or grease both the external and the internal edges and push it on its housing, using a suitable size hose.



6-SHAFT OIL SEALS SERVICE

STEP 1:

Remove the lateral flanges from the crankcase.

Using a hammer insert a flat edge screwdriver in the metal structure of the oil seal.

(Fig. 19)

STEP 2:

Take out the oil seal as indicated in the figure.

(Fig. 20)

STEP 3:

Install the new oil seal after lubricating with oil or grease both the external and internal edges.

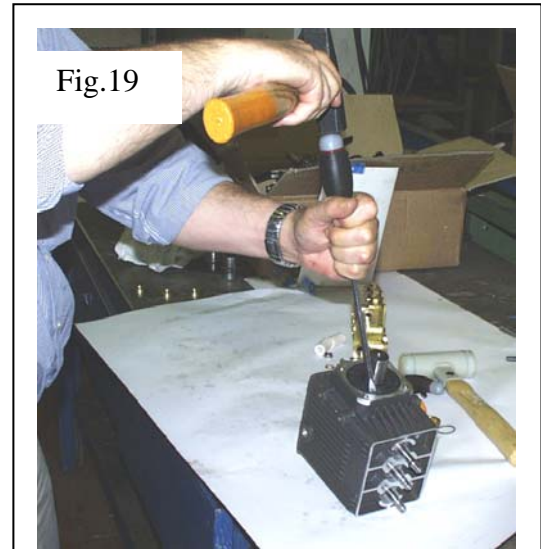

Fig.19

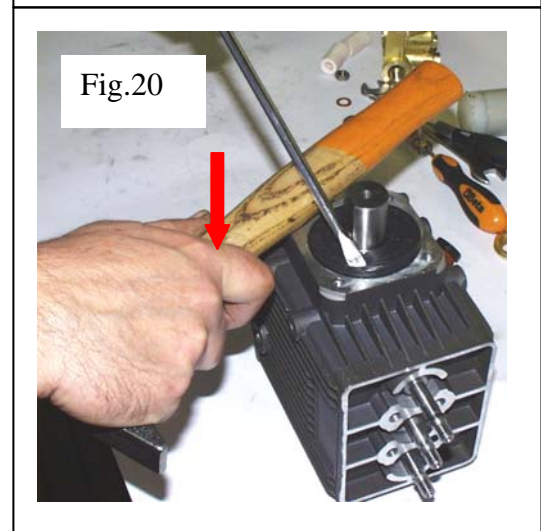

Fig.20

7- REPAIRS TOOLS CHART

| Function | Pump models | Part nr. |
|--|--|-------------------------|
| Extractors to take out seals | W-WJ-TW-KWE | See chart - chapter 3.1 |
| Special tool to fit oil seals on plunger rods | W-WJ | 77.2311 |
| | TW-KWE | 77.2311 |
| Special tool to fit oil seal on the crankshaft | WJL-WJL/F-WJS-WJS/F-WEL-WE-WAL-WA-TW-KWE | 77.2316 |
| | WJC-WJC-F | 77.2318 |
| | WJH-WJH/F-WJG | 77.2319 |
| | WESL-WES-WASL-WES-WSG | 77.2351 |
| | TWS-TWSG | 77.2322 |
| Special tool to fit cap | WJ | 77.2317 |

All the tools (for ex. extractors, proper assembly tools, etc.), to perform the above mentioned operations can be supplied directly, on request, by Idromeccanica Bertolini.

For any further questions, not included in this manual, consult the operation and maintenance booklet attached to each pump in separate plastic bag. In case of doubts contact Idromeccanica Bertolini or the dealer from you bought the pump.